

### 9" CURTAINWALL (HIGH ACOUSTIC)

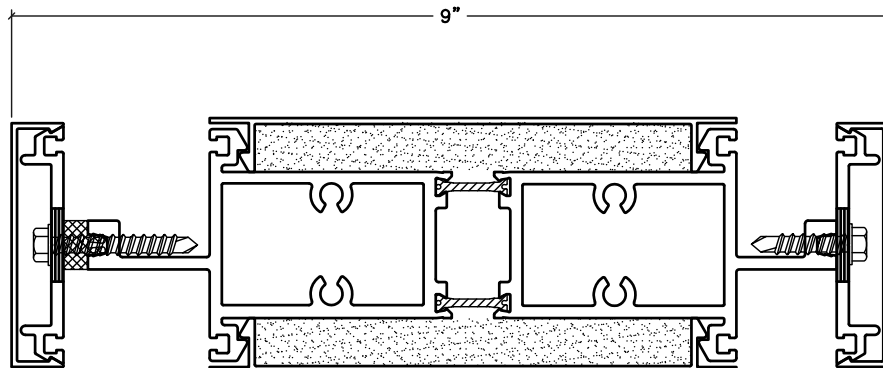

CURTAINWALL FRAME

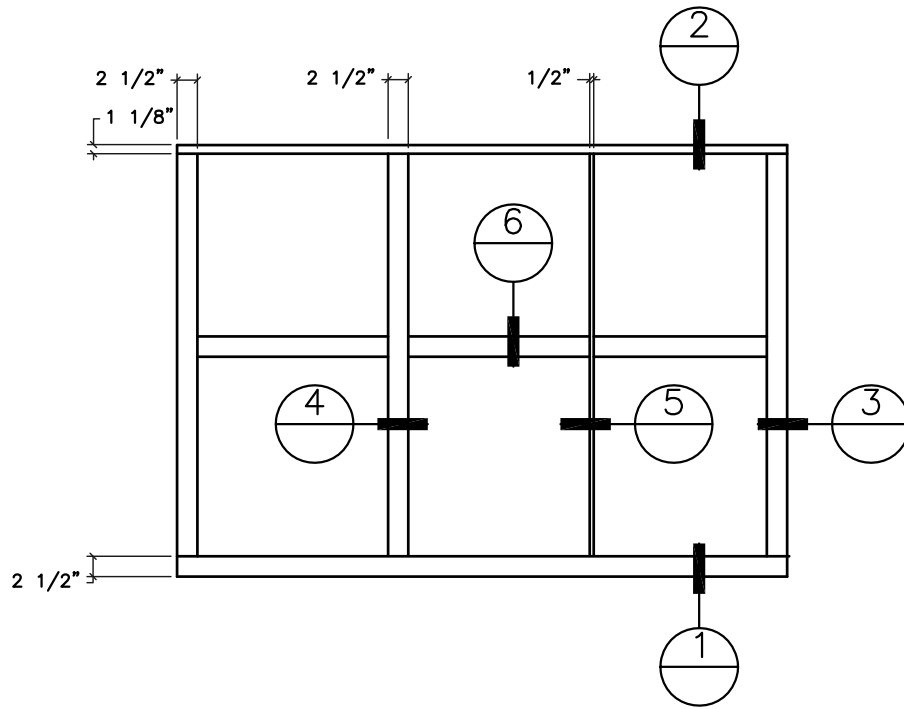
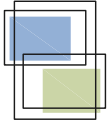

### 9" CURTAINWALL (HIGH ACOUSTIC)

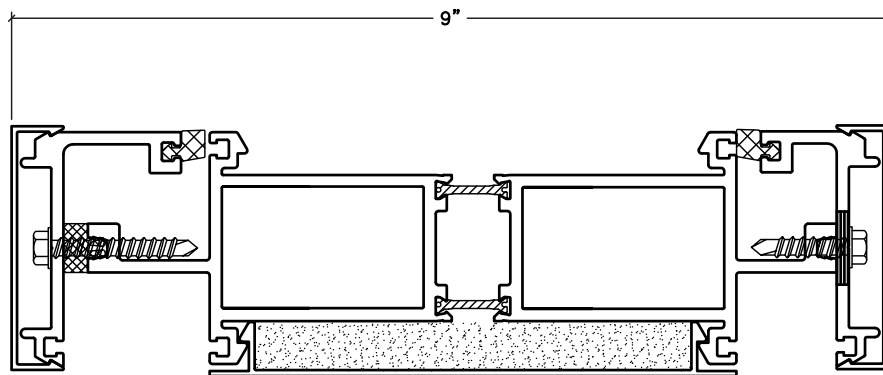
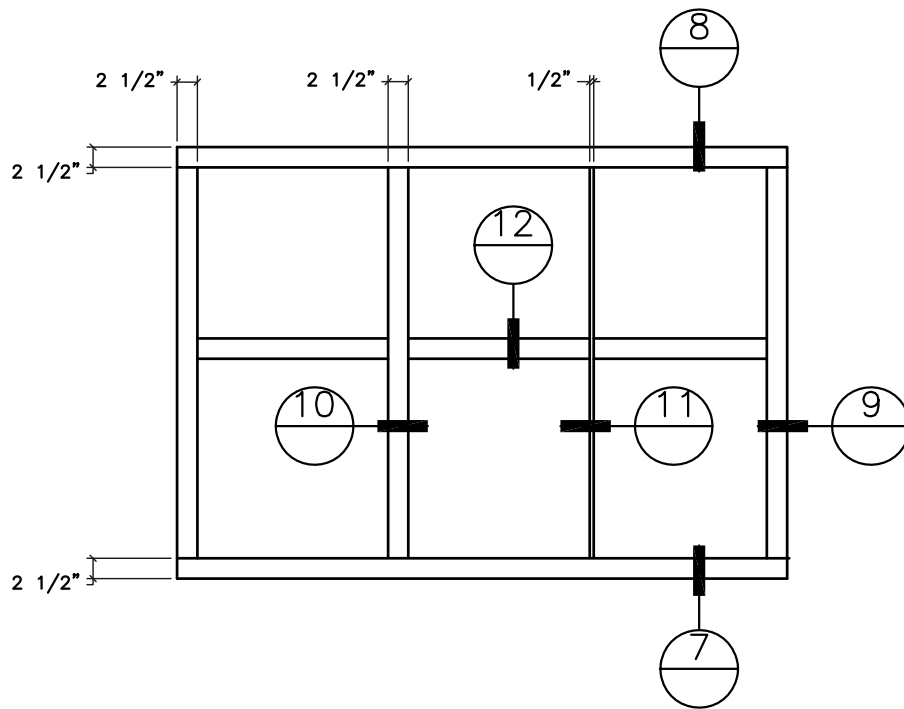

CURTAINWALL FRAME

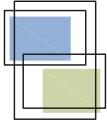

### 9" CURTAINWALL (HIGH ACOUSTIC)

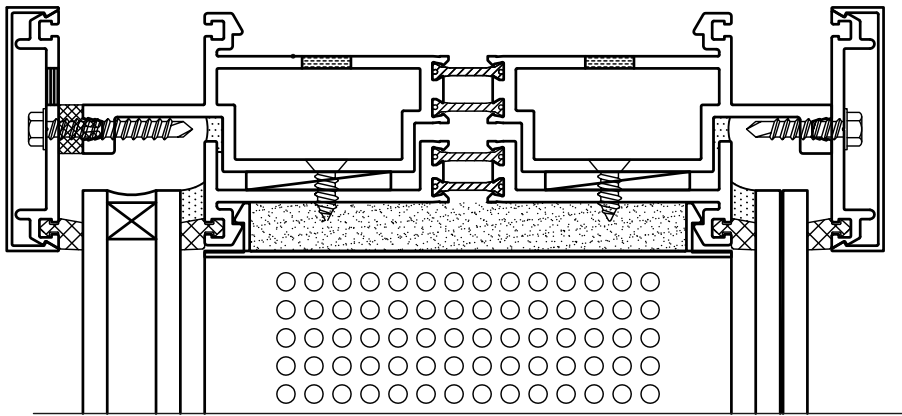

2

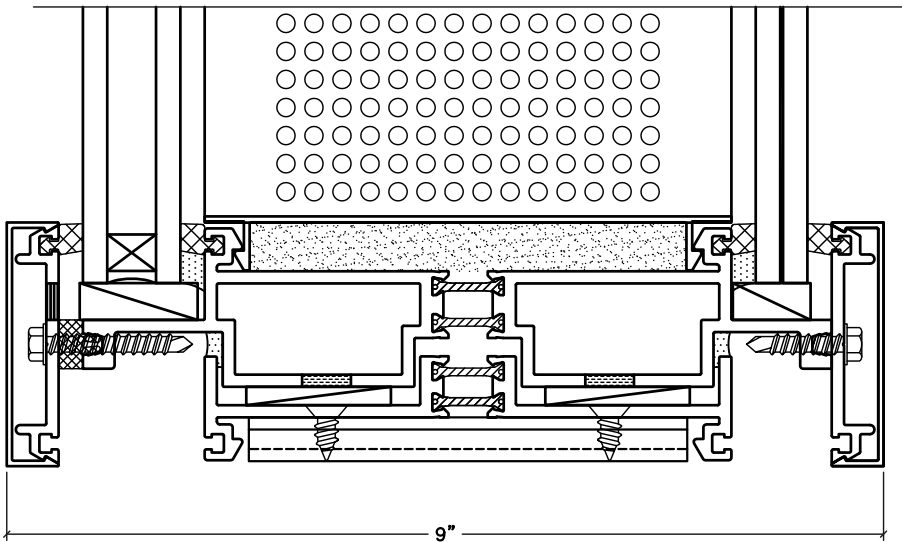

1

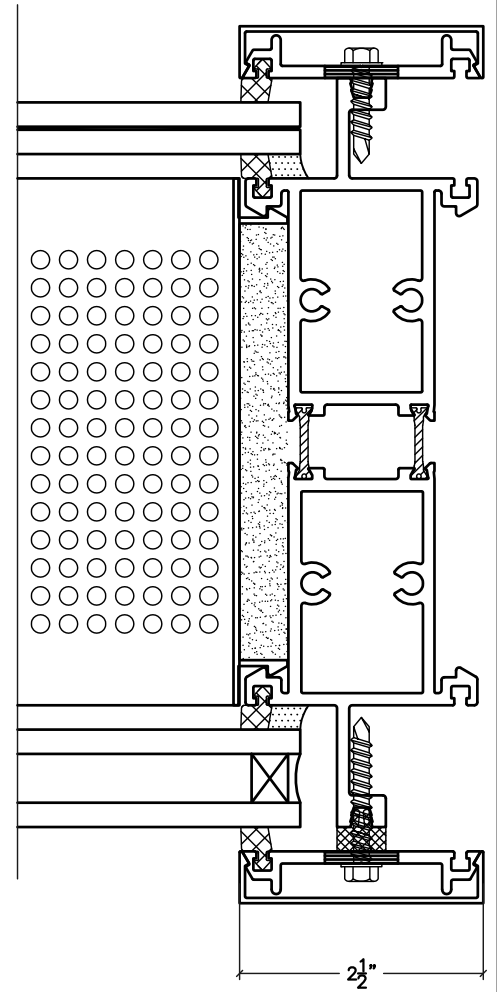

3

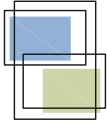

### 9" CURTAINWALL (HIGH ACOUSTIC)

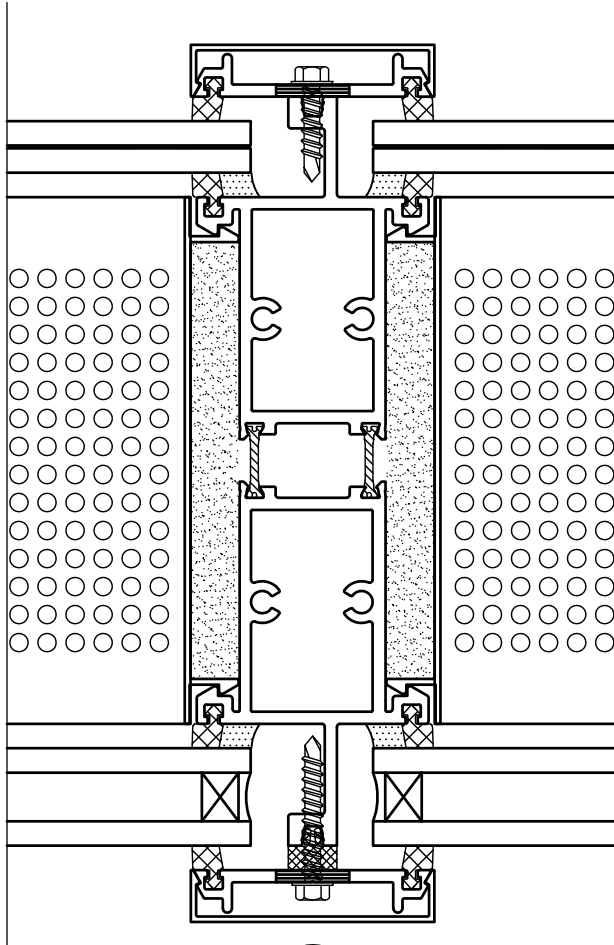

4

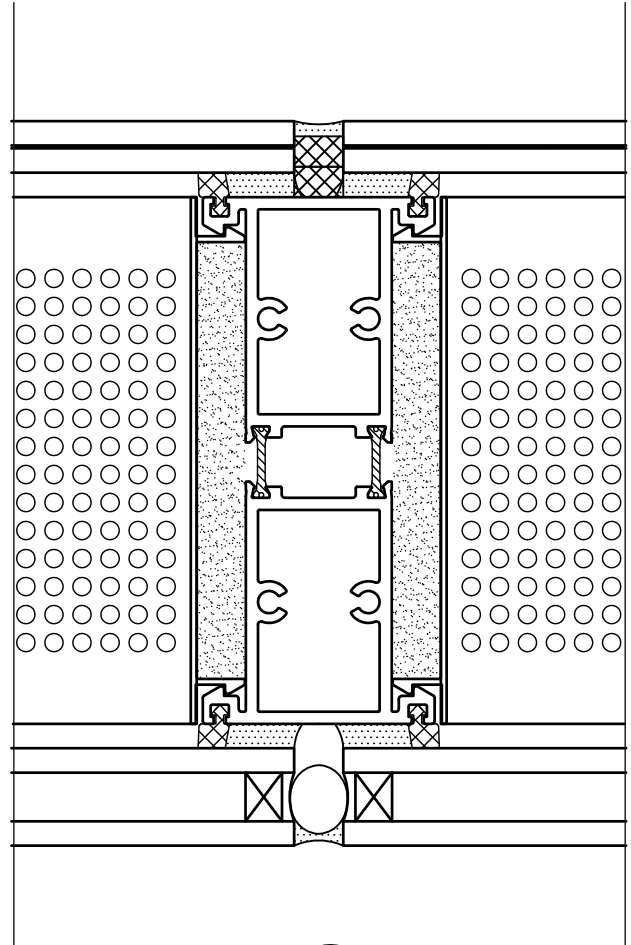

5

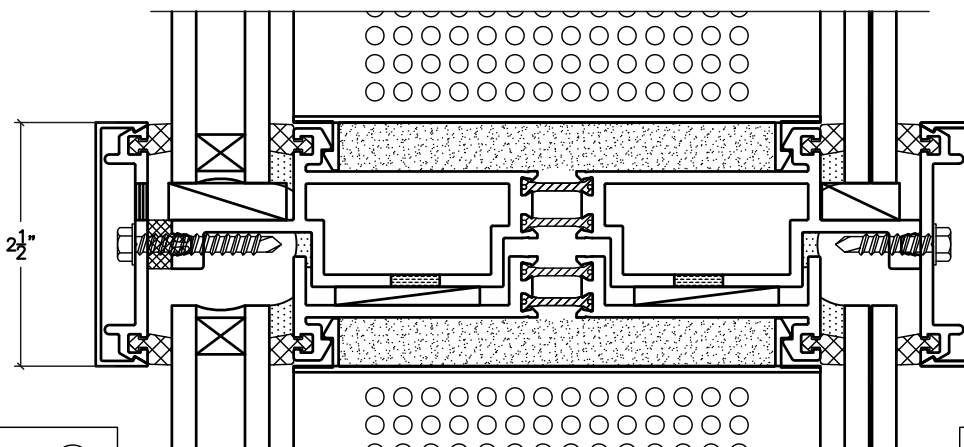

6

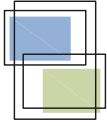

### 9" CURTAINWALL (HIGH ACOUSTIC)

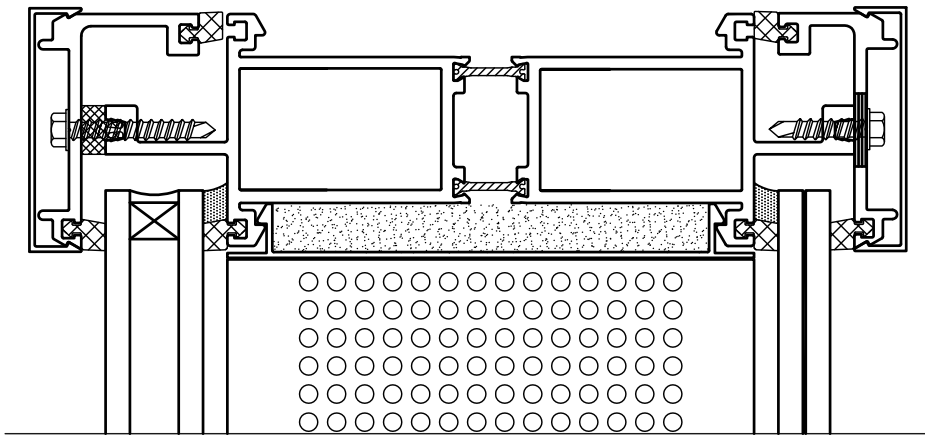

8

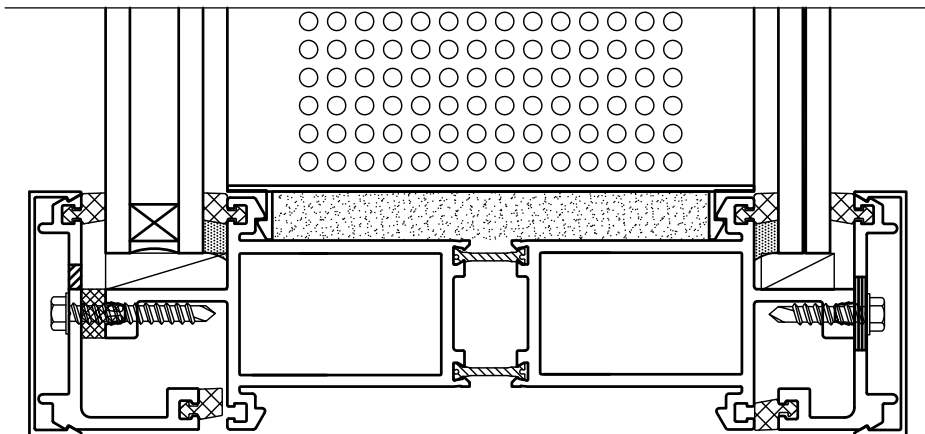

7

9"

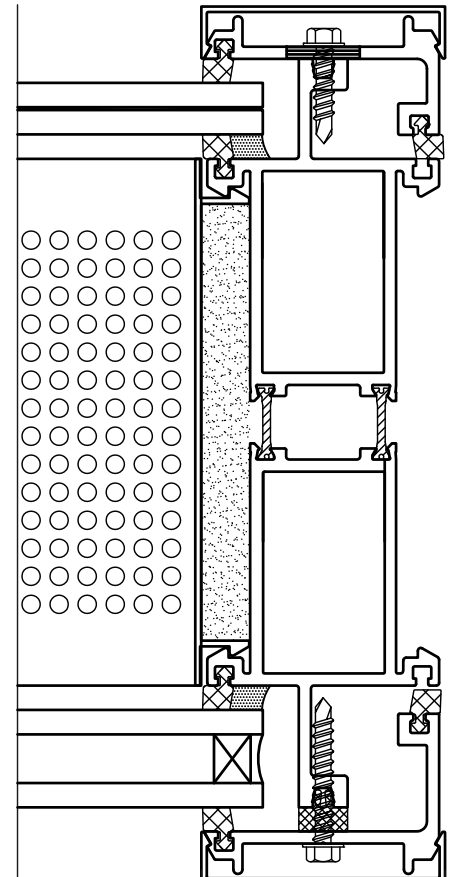

2 1/2"

9

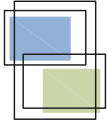

### 9" CURTAINWALL (HIGH ACOUSTIC)

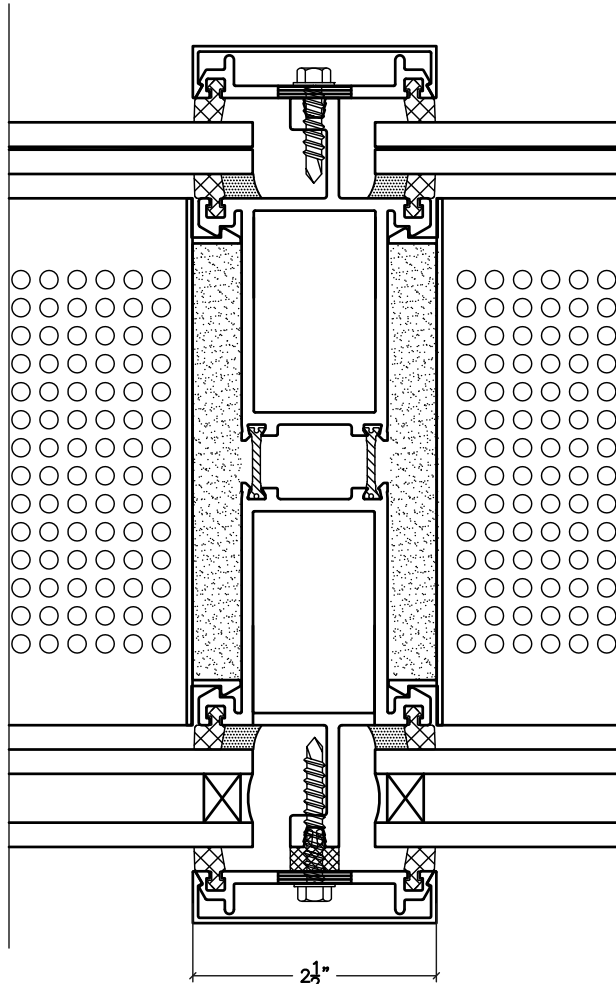

10

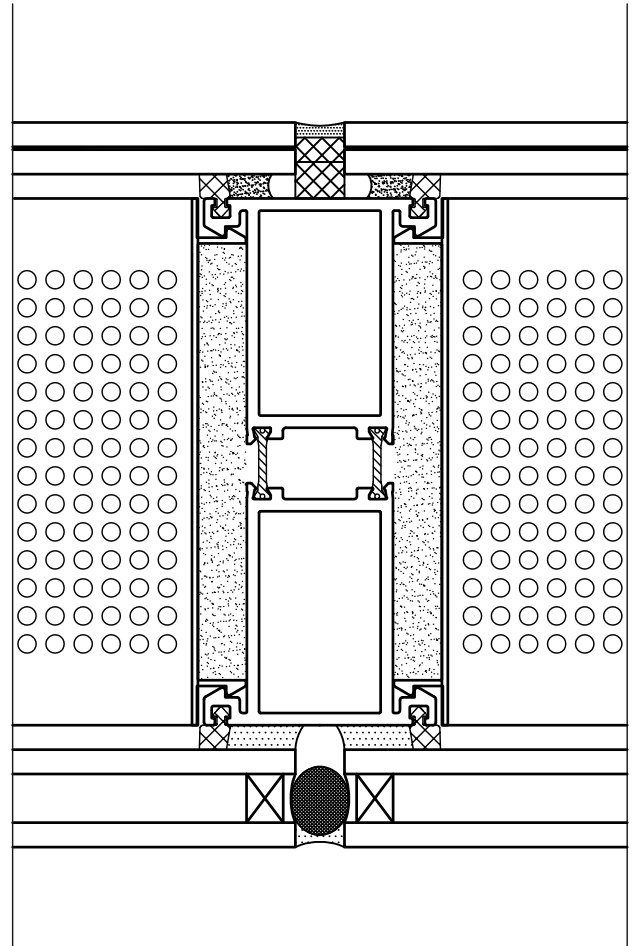

11

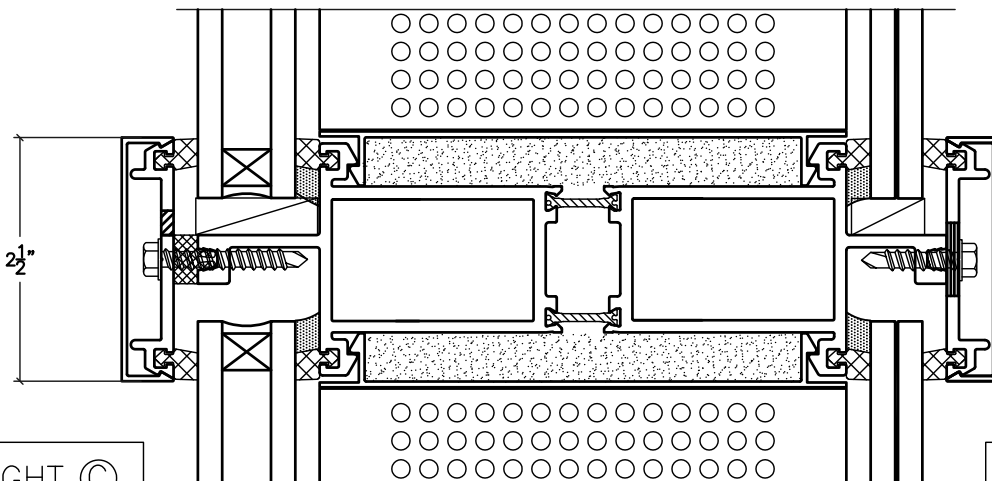

12